



Wastewater

Full-bore, Combination Air Valve for Wastewater

Description

A.R.I. D-26 is a full-bore, Combination Air Valve installed on wastewater transmission systems. The Air Valve is designed to improve hydraulic operation by protecting the pipeline, increasing pipeline efficiency, and reducing energy requirements. The unique body shape of the valve, enables a continuous air gap that separates the wastewater from the sealing mechanism and helps to avoid deposits or blockage.

Installation

- Wastewater & water treatment plants
- Wastewater & effluent water transmission lines

Operation

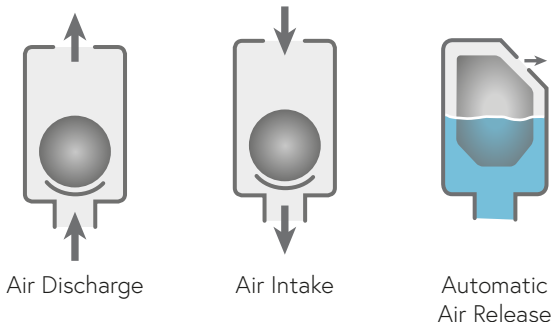

Features and Benefits

Conical body / funnel-shaped lower body	Maximum air gap, minimum body length
	Residue matter falls back into the system pipeline
Continuous air gap	Separates the liquid from the sealing mechanism
Aerodynamic float assembly	High velocity air will not close the valve under rapid filling operation
	Reduces accumulation of fat or grease buildup
	Free movement will not unseal the sealing mechanism
Sealing assembly	Provides smooth, reliable opening/closing, and leak-free sealing over a wide range of pressures
Cushioned spring connection	Cushioned joint allows continuous air discharge under vibration conditions related to turbulence from pump start and shut-off, or from flow fluctuations.
Ball valve	Releases pressure and drains valve prior to maintenance
Cover assembly	Allows complete drop-in replacement, reducing maintenance downtime
Spray Guard®	Flow enhancer, prevents spraying during rapid filling operation
 ATEX certified air valves	ATEX certified air valves are optional by customer request. Certification is conditional upon the customer connecting the designated part on the product to a dedicated ground connection point.

 AIS / BABA compliant	Domestic availability based on size & material
--	--

Technical Specifications

Size range	2" - 8"
Working pressure range	2" (Low pressure) 0.29 - 150 psi
	2" (Standard) 1.5 - 250 psi
	3" (Low pressure) 0.29 - 150 psi
	3" (Standard) 3 - 250 psi
	3" (High pressure) 3 - 360 psi
	4" - 8" (Standard) 1.5 - 250 psi
Testing pressure	1.5 times maximum working pressure
Temperature	Maximum working temperature: 140° F Maximum intermittent temperature: 194° F
Valve coating	Fusion bonded epoxy coating in compliance with standard DIN 30677-2 (applied on Cast Steel and Cast Ductile Iron valves)

Upon ordering, please specify: model, size, working pressure, thread / flange standard and type of liquid

The isolation valve installed under the air valve must be fully open to prevent damage or malfunction and ensure performance within the specifications of the air valve.

For complete installation instructions, please refer to the IOM document.

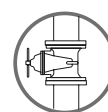

Valve Selection Options

USA models	A.R.I. D-26 P 2",3" - Wastewater combination air valves from Reinforced Nylon, rated for 250 psi.
	A.R.I. D-26 P NS 2",3" - Non-slam wastewater combination air valve from Reinforced Nylon, rated for 250 psi.
	A.R.I. D-26 P LP - Low pressure wastewater combination air valve from Reinforced Nylon, rated for 150 psi.
	A.R.I. D-26 P NS LP - Non-slam low pressure wastewater combination air valve from Reinforced Nylon, rated for 150 psi.
	A.R.I. D-26 - Wastewater combination air valve from Cast Steel, rated for 250 psi.
	A.R.I. D-26 NS - Non-slam wastewater combination air valve from Cast Steel, rated for 250 psi.
	A.R.I. D-26 SS - Wastewater combination air valve from Cast Stainless Steel, rated for 250 psi.
	A.R.I. D-26 SS NS - Non-slam wastewater combination air valve from Cast Stainless Steel, rated for 250 psi.
Valve connection	Threaded BSP/NPT or flanged ends to meet various requested standards
Optional covers (for air discharge direction and for add-on components)	2" Two-directional cover is standard
	3" Optional one-directional or two-directional covers
	4" One-directional elbow for horizontal discharge can be removed to allow for vertical discharge
	6" - 8" Vertical or horizontal discharge outlets
Optional add-on components (2", 3", 4" sizes only)	One-way Out - allows for air discharge only, prevents air intake One-way In - allows air intake only, prevents air discharge Non-slam - discharge-throttling attachment, allows full air intake, throttles air discharge
Additional product configurations	Model D-26 NS with a built-in Non-slam Disc (6" & 8" sizes only) SB Underground Air Valve System (2"+3" sizes only)

Non-slam Add-on Component Data Table for Variable Orifices

Size	Number of orifices	Discharge orifice (inch)	Total NS area (sq.in)	Switching point (psi)	Flow at 5.8 psi (CFM)
2" (50mm)	1 orifice	2"	0.024	Spring loaded normally closed	14
	2 orifices	2"	0.049		19
	3 orifices	2"	0.074		24
3" (80mm)	1 orifice	3"	0.078	Spring loaded normally closed	38
	2 orifices	3"	0.156		52
	3 orifices	3"	0.234		62
4" (100mm)	1 orifice	4"	0.122	Spring loaded normally closed	88
	2 orifices	4"	0.243		112
	3 orifices	4"	0.365		137
6" (150mm)	1 orifice with graduated closure	6"	1.096	0.36	930
8" (200mm)		8"	2.544	0.36	1112

Flow Charts

A.R.I. D-26 2"

Air & Vacuum Flow Rate

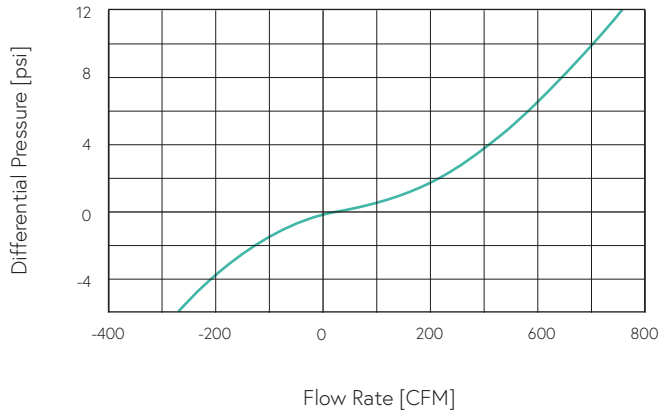

Automatic Air Release Flow Rate

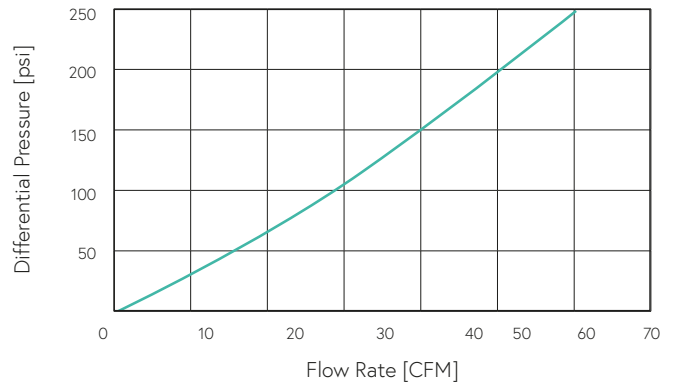

A.R.I. D-26 NS 2"

Air & Vacuum Flow Rate

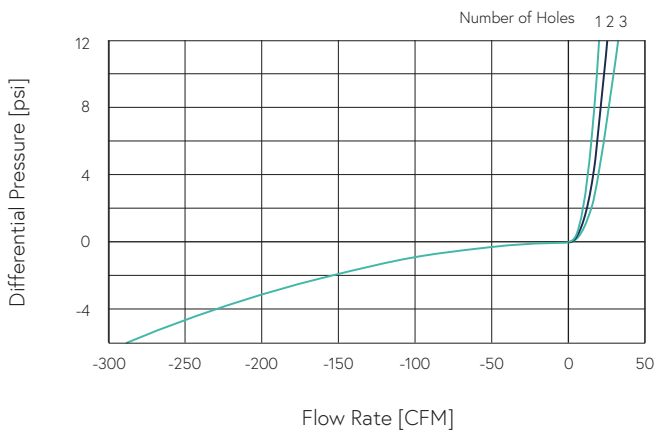

Air Flow Rate

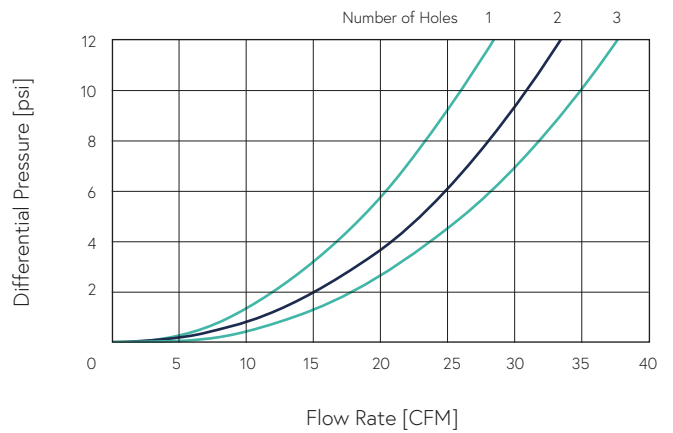

Flow Charts

A.R.I. D-26 3"

Air & Vacuum Flow Rate

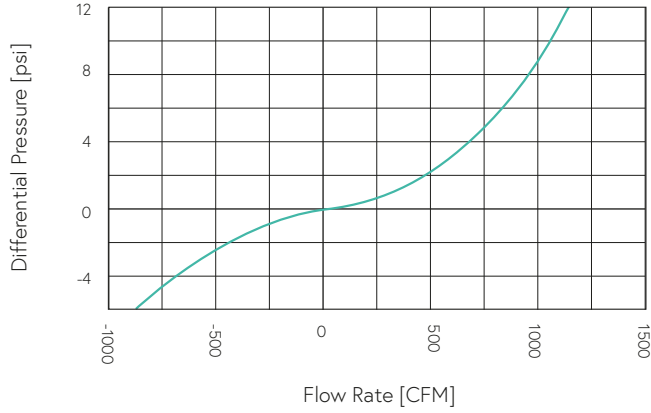

Automatic Air Release Flow Rate

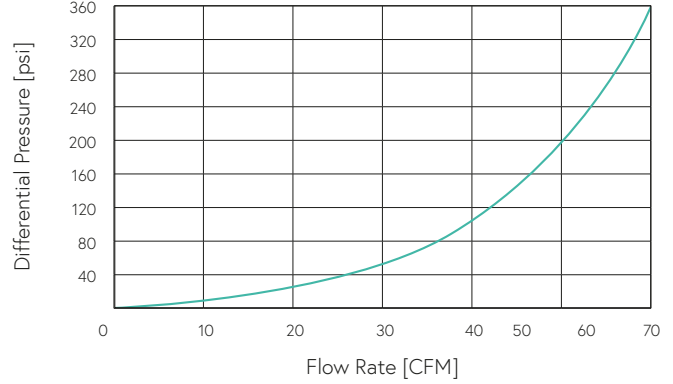

A.R.I. D-26 NS 3"

Air & Vacuum Flow Rate

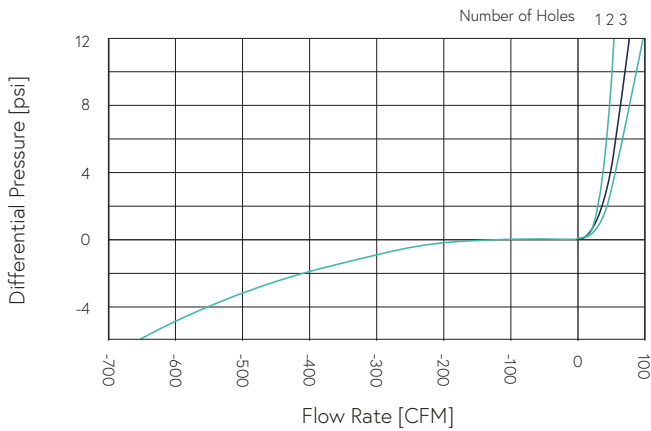

Air Flow Rate

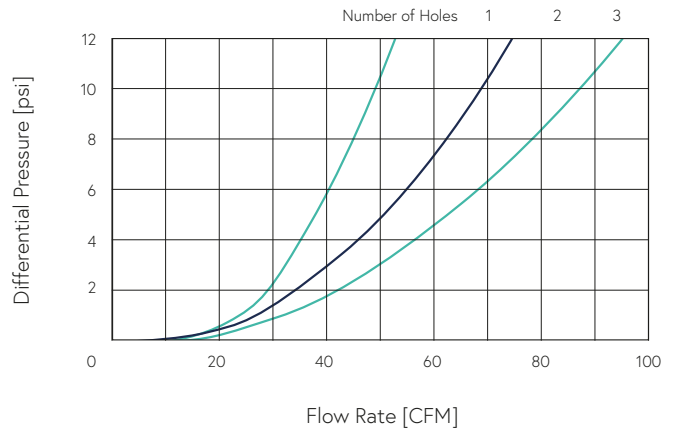

Flow Charts

A.R.I. D-26 4"

Air & Vacuum Flow Rate

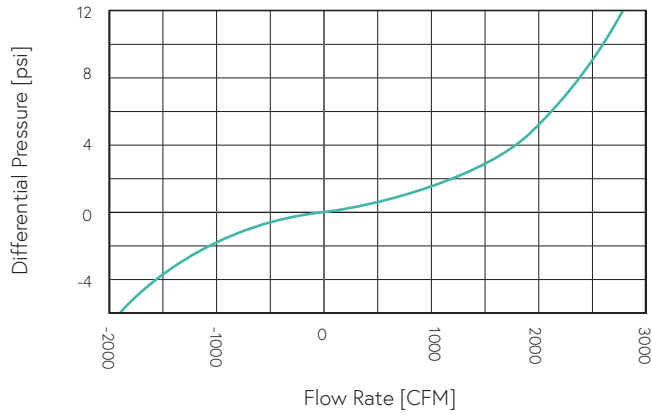

Automatic Air Release Flow Rate

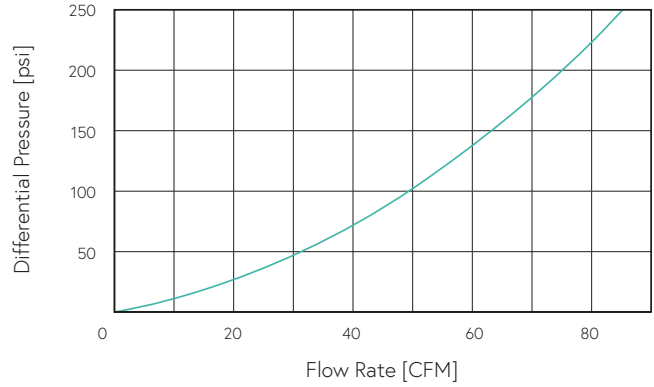

A.R.I. D-26 NS 4"

Air & Vacuum Flow Rate

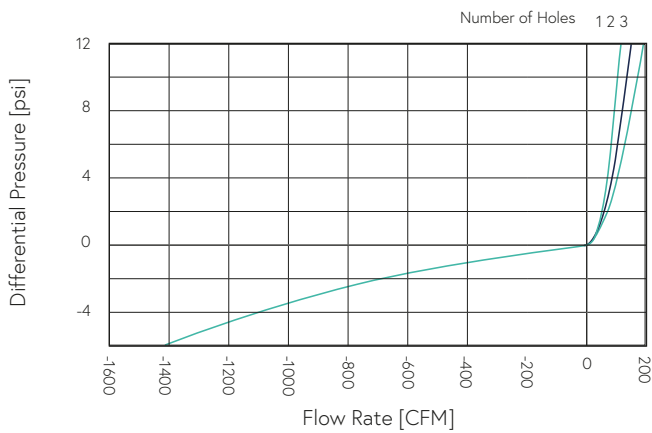

Air Flow Rate

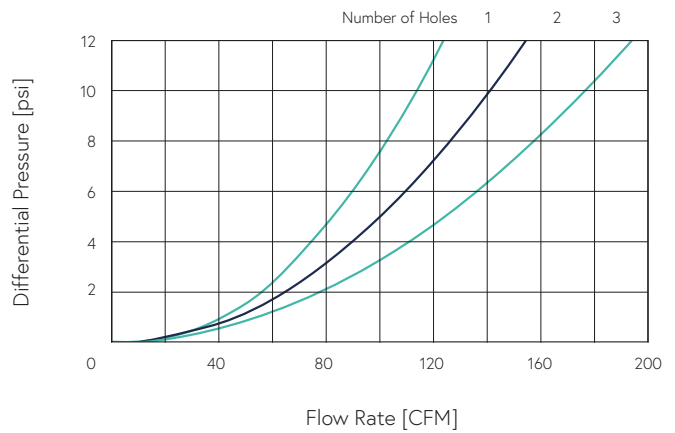

Flow Charts

A.R.I. D-26 6"

Air & Vacuum Flow Rate

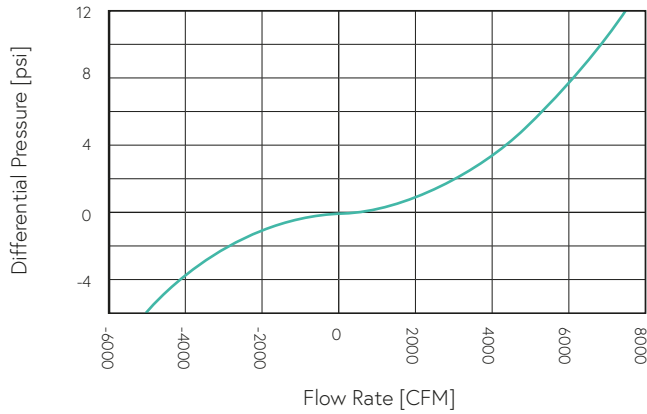

Automatic Air Release Flow Rate

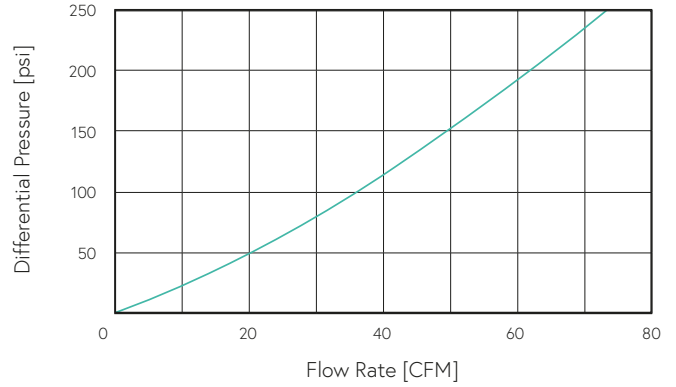

A.R.I. D-26 NS 6"

Air & Vacuum Flow Rate

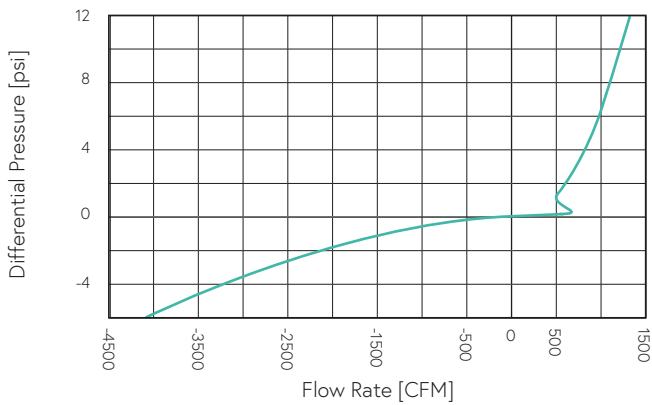

Air Discharge Switching Region

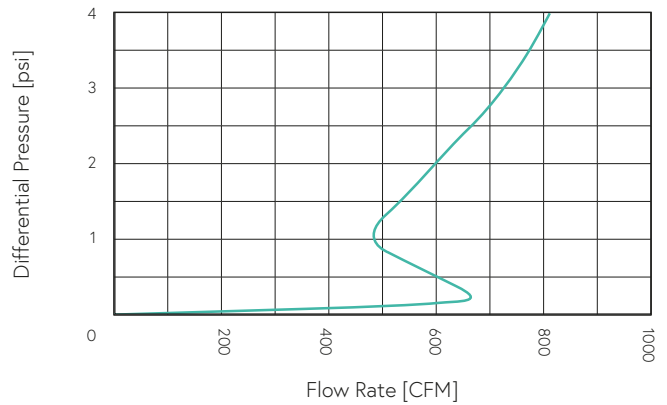

Flow Charts

A.R.I. D-26 8"

Air & Vacuum Flow Rate

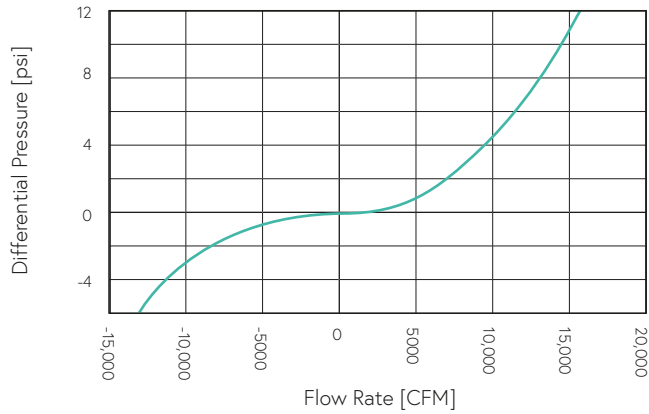

Automatic Air Release Flow Rate

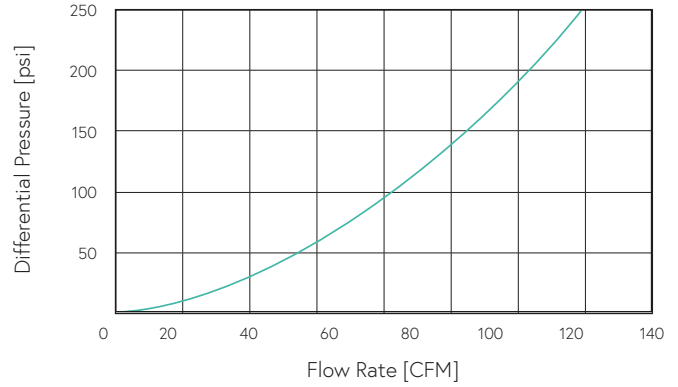

A.R.I. D-26 NS 8"

Air & Vacuum Flow Rate

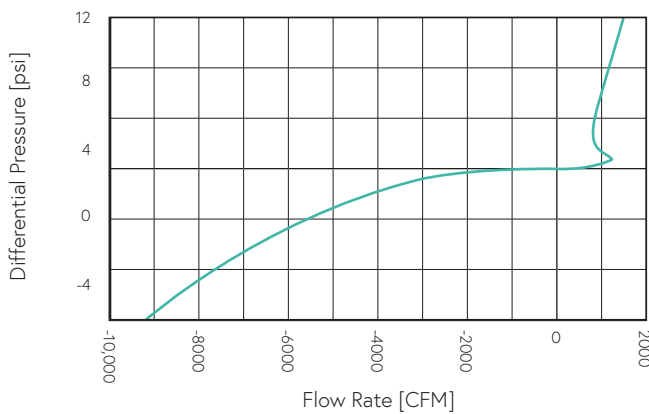

Air Discharge Switching Region

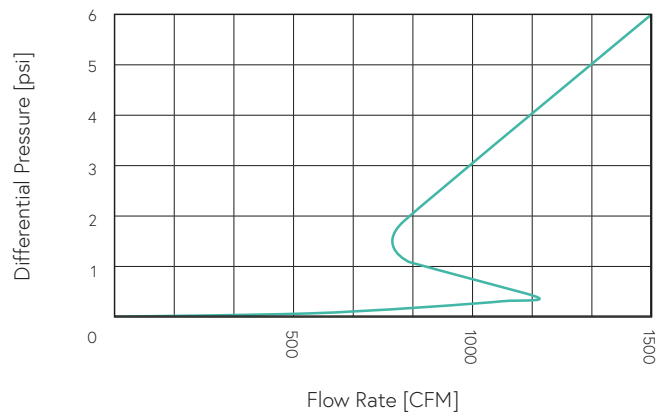

➤ Dimensions and Weight

Size	Dimensions (inch)			Connection	Weight (lbs)		Orifice Area (sq.in)	
	A	B	C		D	RN	ST ST	A / V
A.R.I. D-26 2" (50 mm) THR	10.1	21.3	9.7	2" NPSM Female	18	29	3.04	0.0133
A.R.I. D-26 2" (50 mm) FL	10.1	21.6	9.7	2" NPSM Female	19	35	3.04	0.0133
A.R.I. D-26 NS 2" (50 mm) THR	12.9	21.3	9.7	2" NPSM Male	19	30	3.04	0.0133
A.R.I. D-26 NS 2" (50 mm) FL	12.9	21.6	9.7	2" NPSM Male	20	36	3.04	0.0133
Two-directional cover					Cast Steel	ST ST		
A.R.I. D-26 3" (80 mm) THR	19.3	24.2	16.2	3" NPSM Female	48	51	7.787	0.024
A.R.I. D-26 3" (80 mm) FL	19.3	24.2	16.2	3" NPSM Female	54	56	7.787	0.024
A.R.I. D-26 NS 3" (80 mm) THR	23.6	24.2	16.2	3" NPSM Male	50	53	7.787	0.024
A.R.I. D-26 NS 3" (80 mm) FL	23.6	24.2	16.2	3" NPSM Male	55	57	7.787	0.024
Two-directional cover (RN)					RN			
A.R.I. D-26 3" (80 mm) THR	13.7	23.9	13.8	3" NPSM Female	33	-	7.787	0.024
A.R.I. D-26 3" (80 mm) FL	13.7	24.4	13.8	3" NPSM Female	34	-	7.787	0.024
A.R.I. D-26 NS 3" (80 mm) THR	17.0	23.9	13.8	3" NPSM Male	34	-	7.787	0.024
A.R.I. D-26 NS 3" (80 mm) FL	17.0	24.4	13.8	3" NPSM Male	36	-	7.787	0.024
					DI	ST ST		
A.R.I. D-26 4" (100 mm) FL	19.8	32.4	18.0	4" Flanged NPSM F	96	101	12.17	0.048
A.R.I. D-26 NS 4" (100 mm) FL	22.5	33.1	18.0	4" Flanged NPSM F	107	112	12.17	0.048
Vertical Cover					DI	ST ST		
A.R.I. D-26 6" (150 mm) FL	19.4	32.3	19.6	6" Flanged / Grooved	206	98.0	27.39	0.048
A.R.I. D-26 8" (200 mm) FL	24.1	42.2	22.3	8" Flanged / Grooved	328	157.0	48.67	0.048
Horizontal Cover					DI	ST ST		
A.R.I. D-26 6" (150 mm) FL	20.7	36.7	19.6	6" Flanged / Grooved	220	106.0	27.39	0.048
A.R.I. D-26 8" (200 mm) FL	25.2	48.4	22.3	8" Flanged / Grooved	350	164.0	48.67	0.048

FL - Flanged
 THR - Threaded
 RN - Reinforced Nylon
 DI - Ductile Iron

NOTE

The cover assembly with the discharge elbow can be set in four directions. Dimension A in the picture and in the table shows the maximum product width. This width can be reduced by changing the direction.

All product weights and dimensions are approximate, due to the differences in flange standards, materials and variable accessories.



Parts List and Specifications | 2" - 3"

No.	Part	Material
1	Cover Assembly	
1a	Orifice Plug	Polypropylene
1b	Cover	Stainless Steel 316
1c	Bolt Assembly	Stainless Steel 316 + Reinforced Nylon
1d	Non-slam Component (optional)	Polypropylene + Stainless Steel
2	Seal Assembly	
2a	Disc Arm	Cast Stainless Steel
2b	Air & Vacuum Disc	Cast Stainless Steel / Reinforced Nylon
2c	Air & Vacuum Seal	EPDM
2d	Air Release Seal & Seat	EPDM & Reinforced Nylon
2e	2e. Seal Cover	Reinforced Nylon
3	Body Assembly	
3a	O-ring	NBR
3b	Spray Guard®	Polypropylene
3c	Body	Reinforced Nylon
3e	1/4" or 1/2" Ball Valve	Stainless Steel
4	Float Assembly	
4a	Domed Nut	Stainless Steel 316
4b	Stopper	Polypropylene
4c	Spring	Stainless Steel 316
4d	Float & Rod	Polypropylene + Stainless Steel 316
5	Base Assembly	
5a	O-ring	NBR
5b	Clamp Assembly	Cast Stainless Steel + Stainless Steel 316
5c	Base	Reinforced Nylon
5d	1/4" or 1/2" Ball Valve	Stainless Steel



Parts List and Specifications | Two-directional Cover Model 3"

No.	Part	Material
1	Cover Assembly	
1a	Orifice Plug	Polypropylene
1b	Cover	Stainless Steel 316
1c	Bolt Assembly	Stainless Steel 316 + Reinforced Nylon
1d	Non-slam Component (optional)	Polypropylene + Stainless Steel
2	Seal Assembly	
2a	Disc Arm	Cast Stainless Steel
2b	Air & Vacuum Disc	Cast Stainless Steel / Reinforced Nylon
2c	Air & Vacuum Seal	EPDM
2d	Air Release Seal & Seat	EPDM & Reinforced Nylon
2e	Seal Cover	Reinforced Nylon
3	Float Assembly	
3a	Domed Nut	Stainless Steel 316
3b	Stopper	Polypropylene
3c	Spring	Stainless Steel 316
3d	Float & Rod	Polypropylene + Stainless Steel 316
4	Body Assembly	
4a	Spray Guard®	Polypropylene
4b	O-ring	NBR
4c	Body	Cast Steel / Stainless Steel 316
4d	1" Ball Valve	Stainless Steel 316



Parts List and Specifications | 4"

No.	Part	Material
1	Cover Assembly	
1a	Flange	
1b	Non-slam Component (optional)	Polypropylene + Stainless Steel
1c	Discharge Elbow	PVC
1d	Cover	Ductile Iron / Stainless Steel 316
1e	Orifice Seat	Stainless Steel 316
2	Seal Assembly	
2a	Guide Rod Assembly	Stainless Steel 316 + Acetal
2b	Air & Vacuum Disc	Reinforced Nylon / Reinforced Polypropylene
2c	Air & Vacuum Seal	EPDM
2d	Air Release Seal & Seat	EPDM & Reinforced Nylon
2e	Seal Cover	Reinforced Nylon
2f	Flow Enhancer	ABS
3	Float Assembly	
3a	Domed Nut	Stainless Steel 316
3b	Stopper	Polypropylene
3c	Spring	Stainless Steel 316
3d	Float & Rod	Stainless Steel 316
4	Body Assembly	
4a	O-ring	NBR
4b	Body	Ductile Iron / Stainless Steel 316
4c	Plug	Stainless Steel 316
4d	1" Ball Valve + Nipple Adapter	Stainless Steel 316

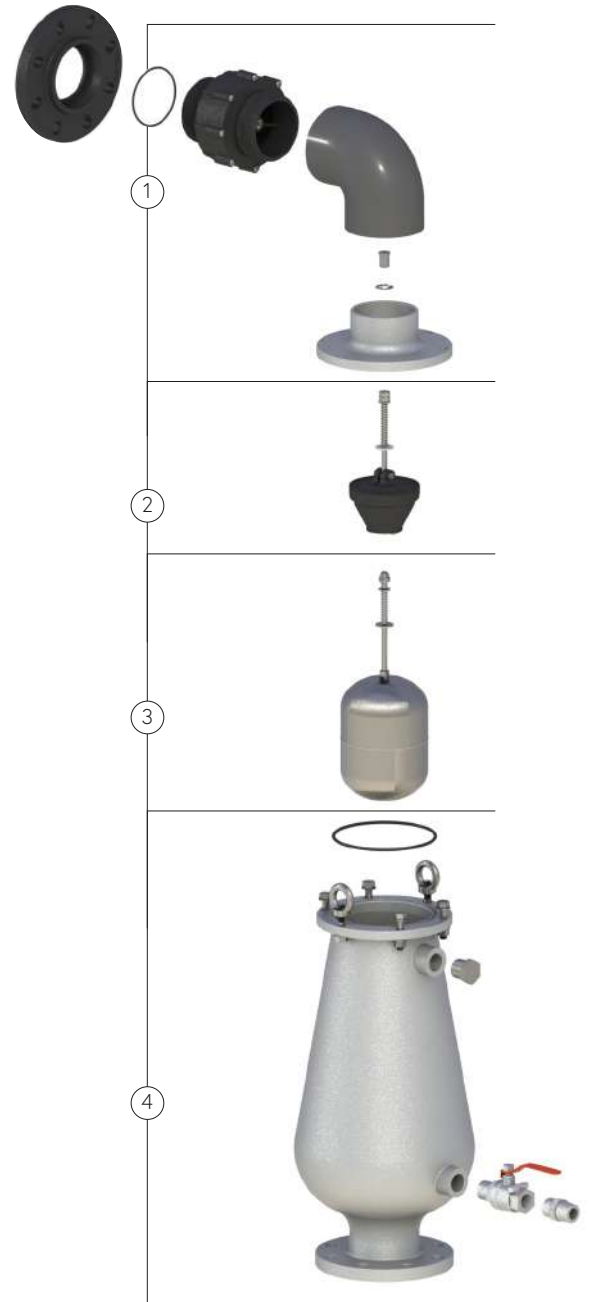

Parts List and Specifications | 6"-8"

No.	Parts	Material
1	Discharge Assembly	
1a	Flange Seal (optional)	NBR
1b	Grooved Flange (optional)	Ductile Iron / Stainless Steel 316
1c	Horizontal Discharge / Vertical Discharge	Ductile Iron / Stainless Steel 316
2	Non-slam Disc (optional)	Ductile Iron / Stainless Steel 316
3	Cover Assembly	
3a	O-ring	EPDM
3b	Cover	Ductile Iron / Stainless Steel 316
3c	Orifice Seat	Stainless Steel 316
4	Float & Seal Assembly	
4a	Guide Rod Assembly	Stainless Steel 316 + Acetal
4b	Air & Vacuum Disc	Reinforced Nylon / Reinforced Polypropylene
4c	Air & Vacuum Seal	EPDM
4d	Air Release Seal & Seat	EPDM & Reinforced Nylon
4e	Seal Cover	Reinforced Nylon
4f	Domed Nut	Stainless Steel 316
4g	Stopper	Stainless Steel 316
4h	Spring	Stainless Steel 316
4i	Float & Rod	Stainless Steel 316
5	Body Assembly	
5a	O-ring	NBR
5b	Body	Ductile Iron / Stainless Steel 316
5c	1" Ball Valve	Stainless Steel 316

