

A.R.I. D-040



Waterworks

Reduced Bore, Combination Air Valve Series

Description

A.R.I. D-040 is a reduced bore Combination Air Valve Series. Installed on liquid transmission systems, the Air Valve is designed to improve hydraulic operation by protecting the pipeline, increasing pipeline efficiency and reducing energy requirements.

Installation

- Pump stations: downstream of the pump and the check valve
- Downstream and upstream of shut-off valves
- Downstream of deep-well pumps
- On long constant-sloped pipeline segments
- At peaks along the pipeline and at peaks relative to hydraulic gradient
- At end lines
- Before water meters
- On strainers and filters

Operation

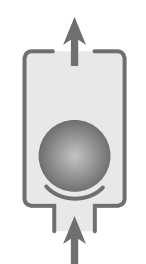

Air Discharge





Air Intake



Automatic
Air Release

Features and Benefits

Reliable operation	Reduces water hammer impact, saves energy and increases system efficiency
Dynamic design	High capacity air discharge
	Easy to install and simple to maintain
Unique orifice seat / seal design	Long-term maintenance-free operation
Accessible discharge outlet	For connecting a vent pipe
Construction materials	UV resistant, non-corrosive and durable
Rolling seal	Leak-free sealing over a wide range of pressure differentials
 ATEX certified air valves	ATEX certified air valves are optional by customer request. Certification is conditional upon the customer connecting the designated part on the product to a dedicated ground connection point
 NSF/ANSI/CAN 61 certified & listed	For drinking water system component
 NSF/ANSI 372 certified & listed	Conforms with lead content requirements for "lead-free" plumbing

Technical Specifications

Size range	½" – 2"		
Working pressure range	0.1 - 10 bar (PN10)	A.R.I. D-040	A.R.I. D-040 C
	0.2 - 16 bar (PN16)	A.R.I. D-040	A.R.I. D-040 C
	0.02 - 10 bar (PN10)	A.R.I. D-040 L	
	0.05 - 16 (PN16)	A.R.I. D-040 L	
Testing pressure	1.5 times maximum working pressure		
Temperature	Maximum working temperature: 60° C Maximum intermittent temperature: 90° C		
Valve coating	Fusion bonded epoxy coating in compliance with standard DIN 30677-2 (Model A.R.I. D-040-C)		

Upon ordering, please specify: model, size, working pressure, thread/flange standard and type of liquid

The isolation valve installed under the air valve must be fully open to prevent damage or malfunction and ensure performance within the specifications of the air valve.

For complete installation instructions, please refer to the IOM document.

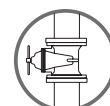

Valve Selection Options

Models	A.R.I. D-040 A.R.I. D-040 C - Protecting Shell A.R.I. D-040 L - Specifically designed to operate with liquids containing small suspended solids
Valve connection	Threaded male BSPT/NPT Flanged ends to meet various requested standard
Standard materials	Reinforced Nylon, Polypropylene, Stainless Steel 316, Cast Ductile Iron Shell
Optional add-on components	One-way Out attachment, allows for air discharge only, prevents air intake One-way in attachment, allows air intake only, not allowing air discharge Non-slam, discharge-throttling attachment, allows full air intake, throttles air discharge (2" only)
Pressure rating	PN10 / PN16 A.R.I. D-040 A.R.I. D-040 C A.R.I. D-040 L



A.R.I. D-040

A.R.I. D-040 C

A.R.I. D-040 L

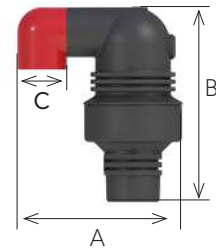

Dimensions and Weight

Size	Dimensions (mm)		Connections	Weight (kg)	Orifice Area (mm ²)		
	max. A	B			C	A / V	Auto.
Nylon Models							
A.R.I. D-040							
1/2" (15mm), 3/4" (20mm), 1" (25mm) THR	100	143	3/8" BSP Female	0.33	100	7.8	
2" (50mm) THR	183	215	1½" BSP Female	1.1	804	12	
2" (50mm) FL	211	222	1½" BSP Female	1.6	804	12	
A.R.I. D-040 L							
1/2" (15mm), 3/4" (20mm), 1" (25mm) THR	100	227	3/8" BSP Female	0.6	100	7.8	
2" (50mm) THR	183	346	1½" BSP Female	2	804	12	
2" (50mm) FL	211	354	1½" BSP Female	2.5	804	12	
Metal Models							
A.R.I. D-040 C							
1/2" (15mm), 3/4" (20mm), 1" (25mm) THR	125	150	3/8" BSP Female	1.2	82	5	
2" (50mm) THR	203	230	1½" BSP Female	5.4	804	12	
2" (50mm) FL	214	230	1½" BSP Female	7.3	804	12	

NOTE

Dimension A in the picture and in the table shows the maximum product width. All product weights are approximate, due to the differences in flange standards, materials and variable accessories.

FL - Flanged THR - Threaded

Flow Charts

A.R.I. D-040

Air & Vacuum Flow Rate

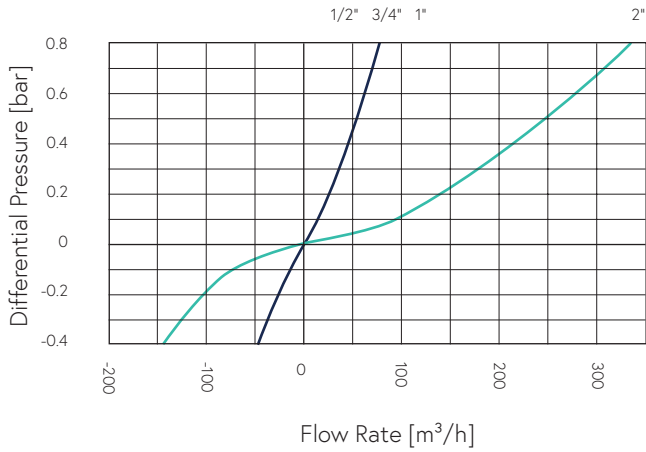

Automatic Air Release Flow Rate

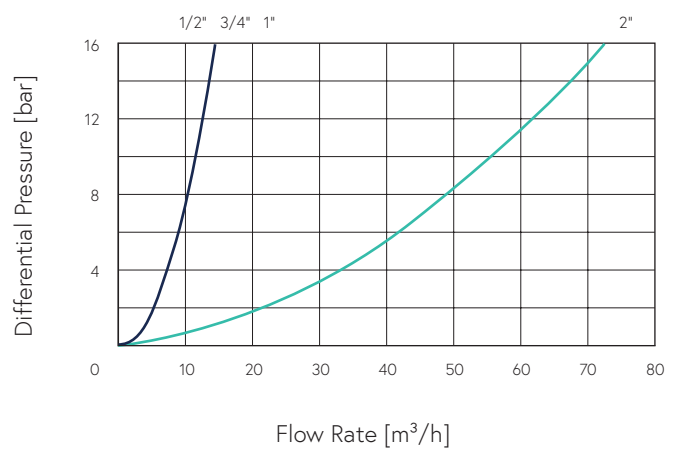

A.R.I. D-040 NS

Air & Vacuum Flow Rate

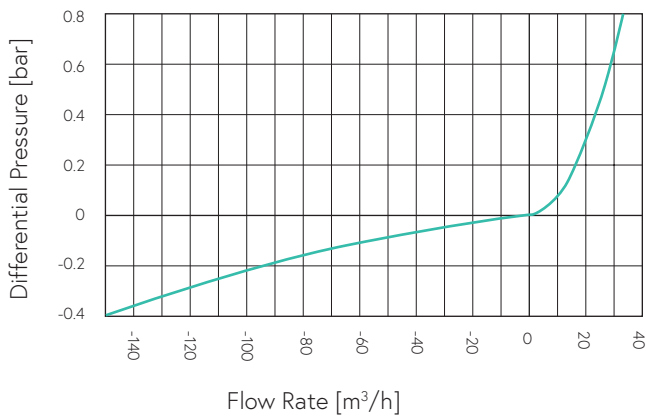

Air Discharge Flow Rate

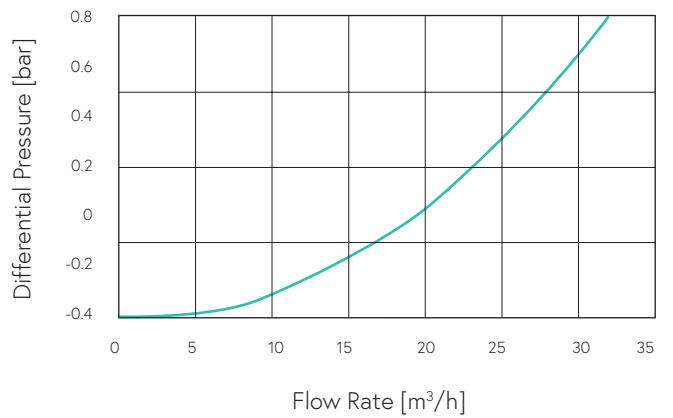

Parts List and Specifications | 1/2 3/4 1"

No.	Part	Material
1	Cover Assembly	
1a	Discharge Outlet	Polypropylene
1b	Body	Reinforced Nylon / Polypropylene
2	Air Release / Air & Vacuum Assembly	
2a	Clamping Stem	Reinforced Nylon / Polypropylene
2b	Float	Foamed Polypropylene
2c	Rolling Seal	EPDM / VITON
3	Base Assembly	
3a	O-ring	NBR / VITON
3b	Base	Reinforced Nylon / Polypropylene

NOTE
Polypropylene for PN10 models only



Parts List and Specifications | 2"

No.	Part	Material
1	Cover Assembly	
1a	Discharge Outlet	Polypropylene
1b	One-way or NS Check Valve (optional)	Reinforced Nylon
1c	Body	Reinforced Nylon / Polypropylene
2	Air Release / Air & Vacuum Assembly	
2a	Clamping Stem	Reinforced Nylon / Polypropylene
2b	Float	Foamed Polypropylene
2c	Seal Assembly	
	Screws	Stainless Steel
	Plug Cover	Reinforced Nylon / Polypropylene
	Rolling Seal	EPDM / VITON
	Plug	Reinforced Nylon / Polypropylene
2d	O-ring	NBR / VITON
3	Base Assembly	
3a	O-ring	NBR / VITON
3b	Base	Reinforced Nylon / Polypropylene
4	Optional Flange Assembly	
4a	O-ring	NBR
4b	Flange	Reinforced Nylon



NOTE
Polypropylene for PN10 models only

Parts List and Specifications | 1/2 3/4 1"

No.	Part	Material
1	Cover Assembly	
1a	Discharge Outlet	Polypropylene
1b	Body	Reinforced Nylon / Polypropylene
2	Air Release / Air & Vacuum Assembly	
2a	Clamping Stem	Reinforced Nylon / Polypropylene
2b	Float	Foamed Polypropylene
2c	Rolling Seal	EPDM / VITON
3	Extension Assembly	
3a	Extension	Reinforced Nylon / Polypropylene
3b	O-ring	NBR / VITON
4	Base Assembly	
4a	O-ring	NBR / VITON
4b	Base	Reinforced Nylon / Polypropylene

NOTE
Polypropylene for PN10 models only



Parts List and Specifications | 2"

No.	Part	Material
1	Cover Assembly	
1a	Discharge Outlet	Polypropylene
1b	One-way or NS Check Valve (Optional)	Reinforced Nylon
1c	Body	Reinforced Nylon / Polypropylene
2	Air Release / Air & Vacuum Assembly	
2a	Clamping Stem	Reinforced Nylon / Polypropylene
2b	Float	Foamed Polypropylene
2c	Seal Assembly	
	Screws	Stainless Steel
	Plug Cover	Reinforced Nylon / Polypropylene
	Rolling Seal	EPDM / VITON
	Plug	Reinforced Nylon / Polypropylene
3	Extension Assembly	
3a	Extension	Reinforced Nylon / Polypropylene
3b	O-ring	NBR / VITON
4	Base Assembly	
4a	O-ring	NBR / VITON
4b	Base	Reinforced Nylon / Polypropylene
5	Optional Flange Assembly	
5a	O-ring	NBR
5b	Flange	Reinforced Nylon

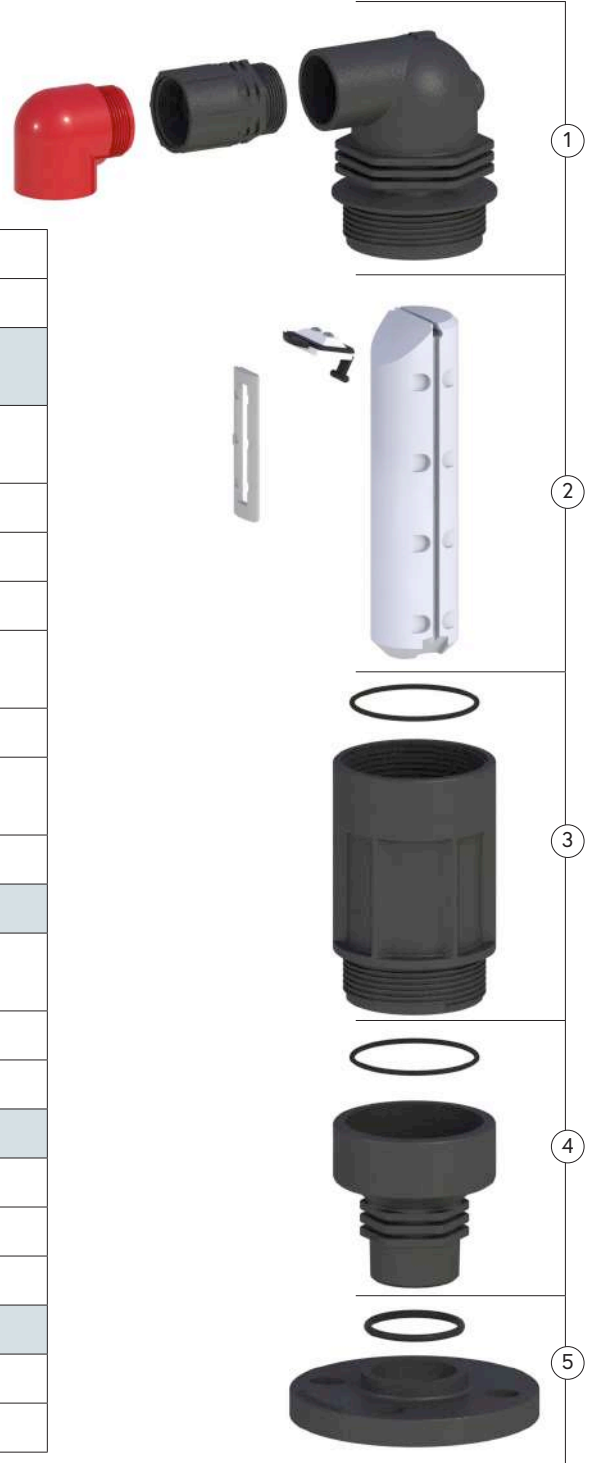

NOTE
Polypropylene for PN10 models only

Parts List and Specifications | ½ ¾ 1"

No.	Part	Material
1	Cover Assembly	
1a	Discharge Outlet	Polypropylene
1b	O-ring	NBR
1c	Pin	BRASS
1d	O-ring	NBR
1e	Shell	Ductile Iron
1f	O-ring	NBR
1g	Body	Reinforced Nylon
2	Air Release / Air & Vacuum Assembly	
2a	Clamping Stem	Reinforced Nylon
2b	Rolling Seal	EPDM
2c	Float	Foamed Polypropylene
3	Base	
3a	O-ring	NBR
3b	Base	Brass / Stainlee Steel 316

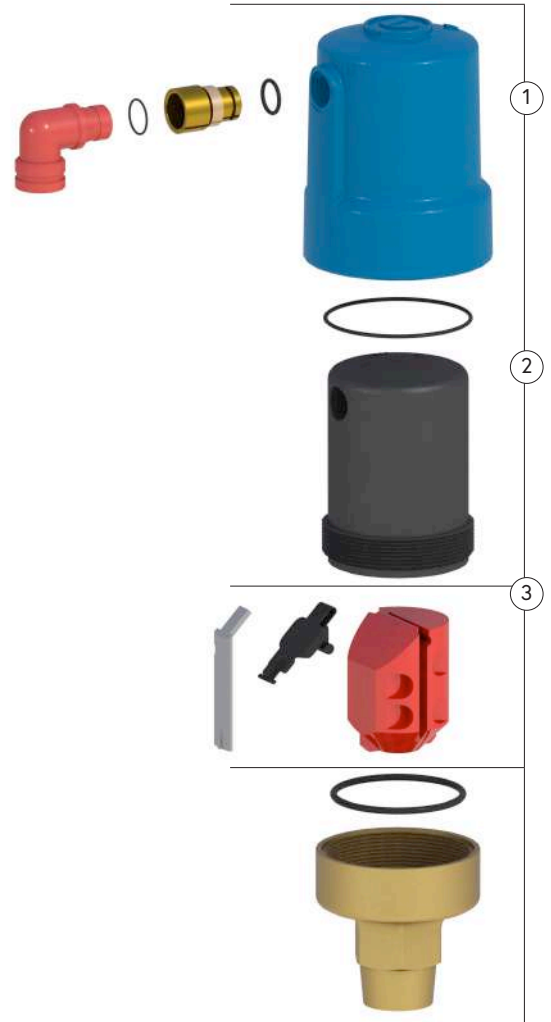

Parts List and Specifications | 2"

No.	Part	Material
1	Cover Assembly	
1a	Discharge Outlet	Polypropylene
1b	One-way / NS (Optional)	Reinforced Nylon
1c	Shell	Ductile Iron
1d	Body	Reinforced Nylon
2	Air Release / Air & Vacuum Assembly	
2a	Clamping Stem	Reinforced Nylon
2b	Rolling Seal Assembly	EPDM / Reinforced Nylon / Stainless Steel 316
2c	Float	Foamed Polypropylene
3	Base	
3a	O-ring	NBR
3b	Bolts, Nuts & Washers	Steel/Stainless Steel 316
3c	Base Threaded / Flanged	Ductile Iron

